

Star Trans

Transforming Technology



LOW VOLTAGE-TRANSFORMER



POWER ISOLATION
TRANSFORMER

UNIVERSAL CONTROL- AND SAFETY ISOLATION
RESP ISOLATING TRANSFORMER



General Data

Rated input voltage 230 V AC
Rated output voltage 230 V AC
Rated power 1300 - 10000 VA
Insulation class H
Maximum ambient temperature 50 °C
Efficiency up to 96
Degree of protection IP00
Frequency 50/60 hz

Advantages

Universal input voltages 208 to 600 VAC
Very good switch-on behaviour thanks to reduced starting currents
High performance for the volume thanks to compact design
Very good corrosion protection and low noise thanks to vacuum

Applications

Control transformer for the electrical isolation of the input and output sides.

The design of the transformer makes it suitable for the supply of control systems complying with VDE 0113.

Sample application













Control transformer
to: VDE 0570 Teil 2-2, DIN EN 61558-2-2, EN 61558-2-2, IEC 61558-2-2, UL 5085-1/-2, CSA 22.2 No.66
Safety isolating transformer
to: VDE 0570 Teil 2-6, DIN EN 61558-2-6, EN 61558-2-6, IEC 61558-2-6, UL 5085-1/-2, CSA 22.2 No.66
Isolating transformer
to: VDE 0570 Part2-4, DIN EN 61558-2-4, EN 61558-2-4, IEC 61558-2-4, UL 5085-1/-2, CSA 22.2 No.66

Approvals

UL 5085-1/-2, CSA 22.2 No.66



UNIVERSAL CONTROL- AND SAFETY ISOLATION
RESP ISOLATING TRANSFORMER

Mechanical data	Type	Terminals	Firing method	Firing screws	Weight	Dimension picture (in mm)	A	B	C	D	E	F
	CT01300-00-00	Screw -type terminals	Base plate	M6	15.5 kg		180	147	205	102	104	8
	CT01600-00-00	Screw -type terminals	Base plate	M6	17.5 kg		180	157	205	102	114	8
	CT02000-00-00	Screw -type terminals	Base plate	M6	21 kg		180	177	205	102	134	8
	CT02500-00-00	Screw -type terminals	Base plate	M8	24.5 kg		210	167	230	142	122	10
	CT03000-00-00	Screw -type terminals	Base plate	M8	31 kg		210	197	230	142	152	10
	CT03500-00-00	Screw -type terminals	Base plate	M8	33.5 kg		210	207	230	142	162	10
	CT04000-00-00	Screw -type terminals	Base plate	M8	40.5 kg		240	209	255	163	156	10
	CT05000-00-00	Screw -type terminals	Base plate	M8	44 kg		240	219	255	163	166	10
	CT06300-00-00	Screw -type terminals	Base plate	M10	65.5 kg		300	234	305	213	176	12
	CT08000-00-00	Screw -type terminals	Base plate	M10	76.5 kg		300	254	305	213	196	12
	CT10000-00-00	Screw -type terminals	Base plate	M10	91.5 kg		300	284	305	213	226	12

Applications

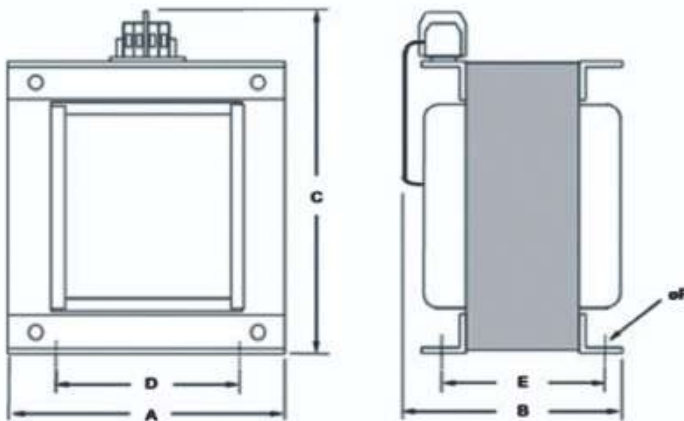

TRANSFORMER

THREE - SINGLE PHASE
POWER ISOLATION
TRANSFORMER



www.startranseg.com